



Asmat[®]
Paspas Sistemleri





Emaar Square Mall

Building entrances are considered as one of the most important parts of the facilities as they give the first impression to the visitors. Therefore they should be decorated aesthetically and functionally. Due to the bidirectional heavy pedestrian, %80 of indoor pollution is formed by the dirt carried inside via entrances.

Asmat matting systems are manufactured both for indoor and outdoor uses by keeping the dirt, dust and moisture outside the buildings. Our matting systems are designed with different insert combinations, dimensions and shapes as per the needs of locations and provide a complete cleaning solution and dry steps by reducing the dirt from course to light level. Properly configured systems help the establishments not only by preventing the slippery floor accidents but also save time and money by lowering the cleaning costs. Durable aluminium profiles and rubber based inserts are manufactured weather-proof while rollable design helps for easy cleaning and saving at freight costs. Entrance mats are generally grouped as per their application areas:

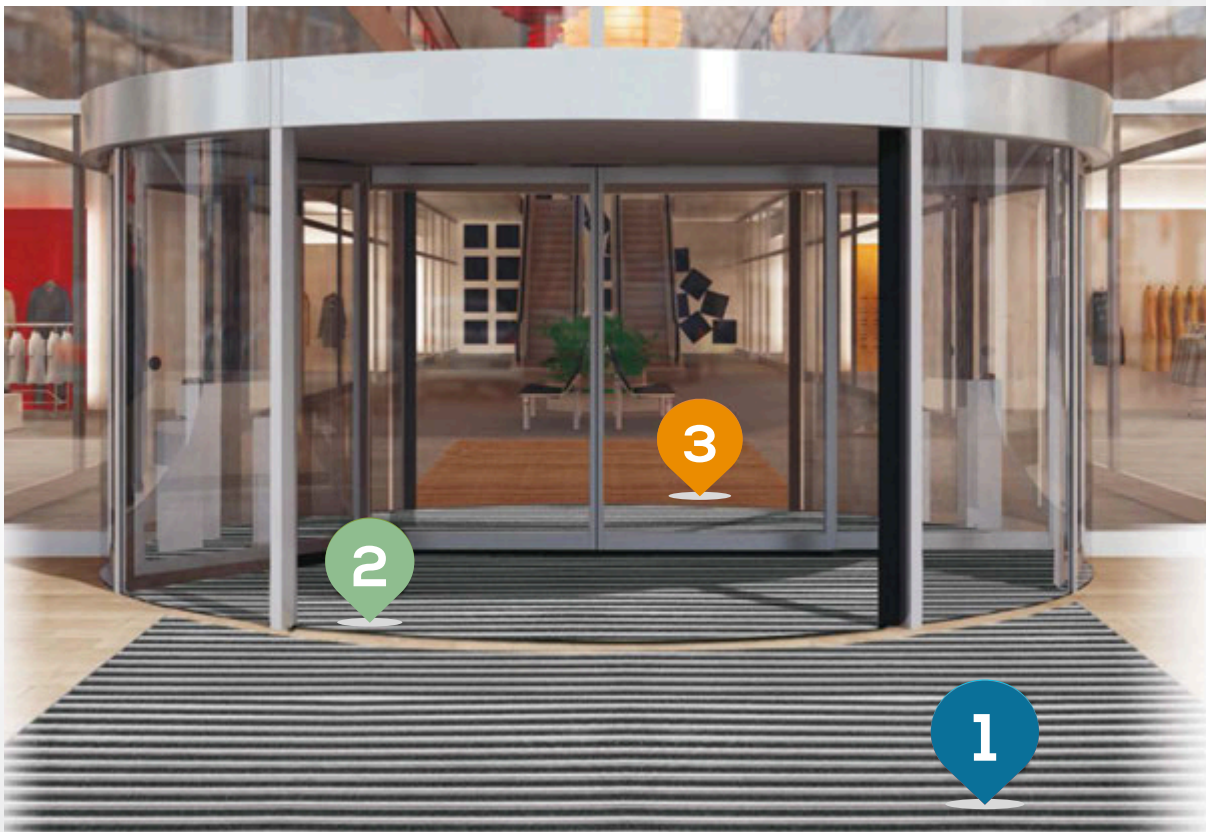

Zone 1: Mostly outdoor area, exposed to rain, sun and severe winter conditions. Scraping and removing initial dirt, mud and moisture is required.

Zone 2: Transition area. Removing any left over dirt and mud before entering the interior space is required.

Zone 3: Indoor area. Cleaning and drying the remains of the dirt and wet before entering the interior floor coverings is required.

For Effective Cleaning at Outdoor Areas



For Effective Cleaning at Indoor Areas



For Effective Cleaning at Outdoor & Indoor Areas

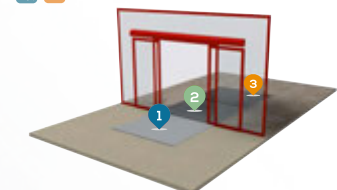

BASE PROFILES



HPE

ELEPHANT



HPH

HIPPO



HPA

ANT



HPD

DOLPHIN



HPW

HIPPO WIDE

CARPET OPTIONS



H RIBBED

GREY - BLUE



GREY



ANTHRACITE



LIGHT BROWN



BORDEAUX

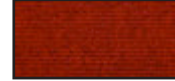

YELLOW



H1 CORN TEXTURED

GREY



YELLOW



ANTHRACITE



HZ NON INFLAMMABLE

ANTHRACITE



RUBBER OPTIONS



L RUBBER

GREY



BLACK



RED



BRUSH OPTIONS



F- HPD 2-3 ROW

GRAY



BLACK



BLUE



RED



B 1 ROW

BLACK



In Elephant Model matting system base profile is produced in aluminium in 13 mm height and 40 mm wide. By using different inserts and modules, the height goes up to 18 mm and the gaps between the modules are 5 /6/ 16 mm. Brush, carpet, rubber and modular scraper inserts are used in the base profile for different zone purposes. Also In Elephant model heel proof connector is a good option to avoid the ladies' shoe heels get jam in the connection gap.



HPE F-K-F

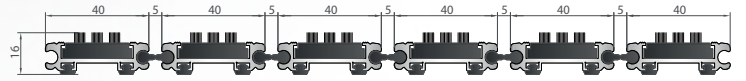

Brush-Connector-Brush

HPE F-A-F

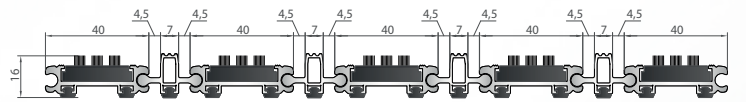

Brush-Scraper-Brush

HPE F-C-F

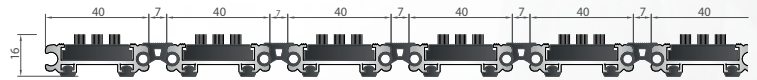

Brush-Heel Proof Connector-Brush

HPE S-K-F

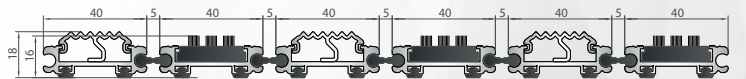

M.Scraper-Connector-Brush

HPE S-K-S

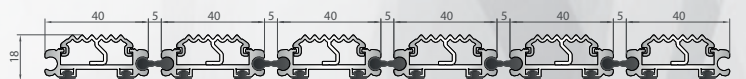

M.Scraper-Connector-M.Scraper

HPE S-C-F

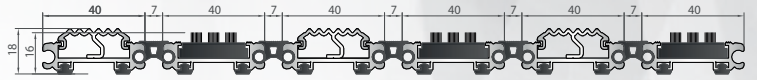

M.Scraper-Heel Proof Connector-Brush

HPE S-C-S

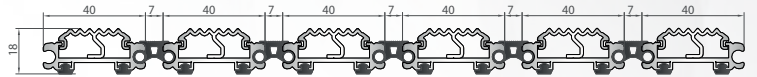
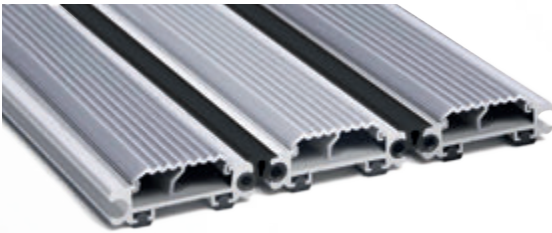

M.Scraper-Heel Proof Connector-M.Scraper

HPE L-K-F

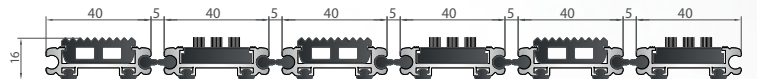

Rubber-Connector-Brush

HPE L-K-S

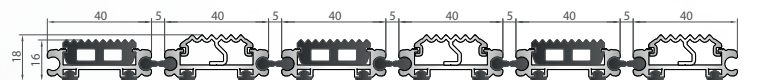
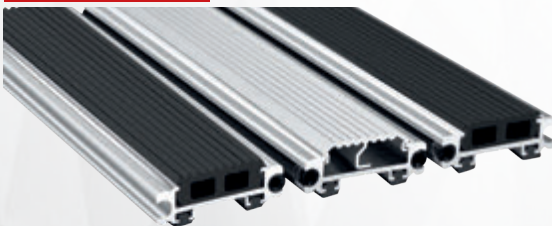

Rubber-Connector-M.Scraper

HPE L-K-L

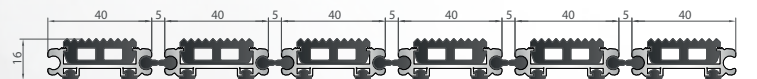
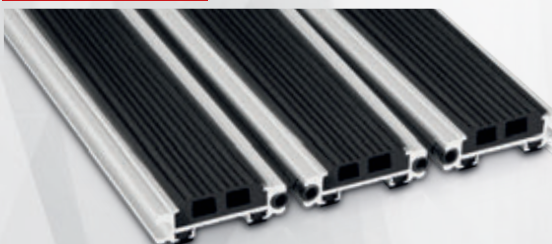

Rubber-Connector-Rubber

HPE L-A-F

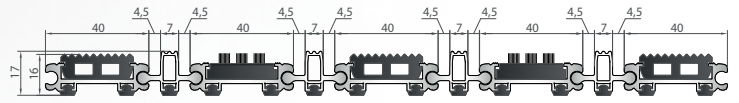
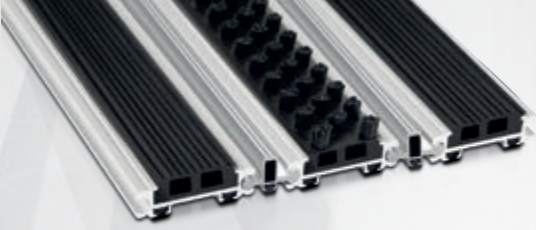

Rubber-Scraper-Brush

HPE L-A-L

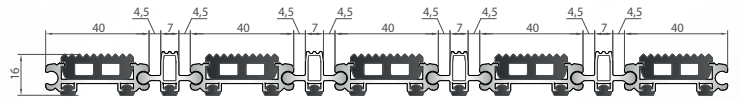
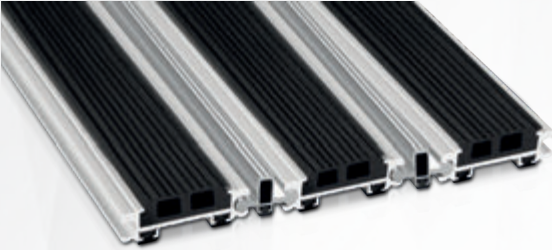

Rubber-Scraper-Rubber

HPE L-C-F

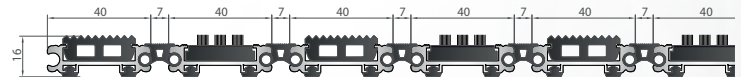

Rubber-Heel Proof Connector-Brush

HPE L-C-S

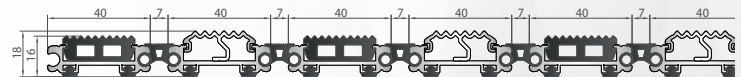
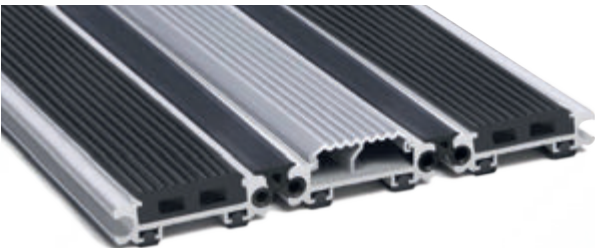

Rubber-Heel Proof Connector-M.Scraper

HPE L-C-L

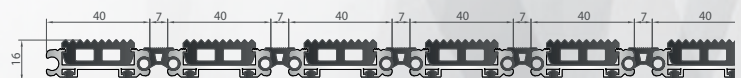

Rubber-Heel Proof Connector-Rubber

HPE L-K-H

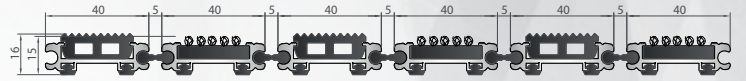
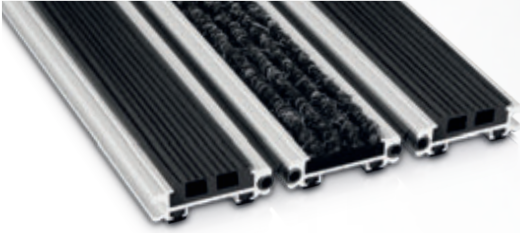

Rubber-Connector-Carpet

HPE L-A-H

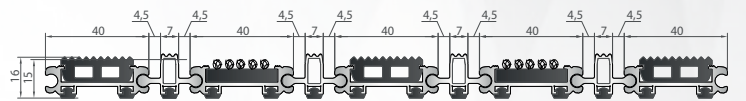
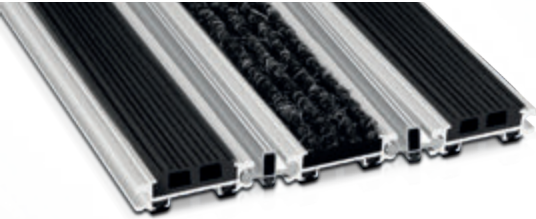

Rubber-Scraper-Carpet

HPE H-C-L

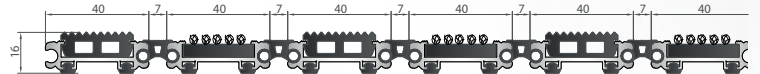

Rubber- Heel Proof Connector-Carpet

HPE H-K-F

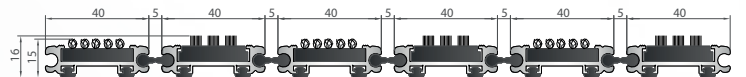
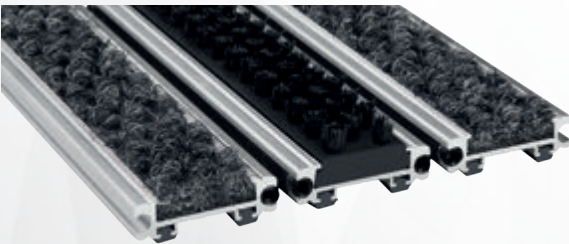

Carpet-Connector-Brush

HPE H-K-S

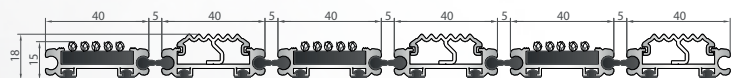

Carpet-Connector-M.Scraper

HPE H-K-H

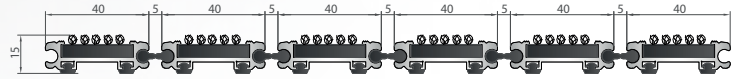

Carpet-Connector-Carpet

HPE H-C-F

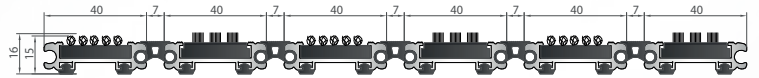
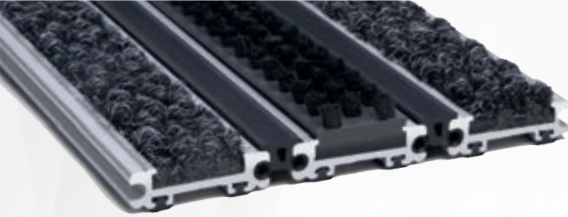

Carpet-Heel Proof Connector-Brush

HPE H-C-S

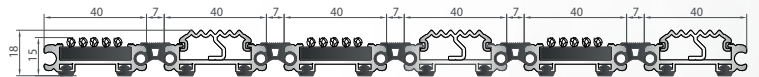

Carpet-Heel Proof Connector-M.Scraper

HPE H-C-H

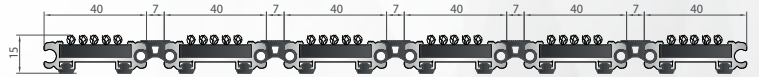
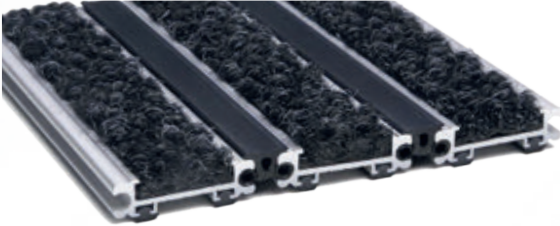

Carpet-Heel Proof Connector-Carpet

HPE H-A-F

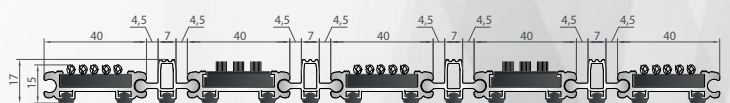
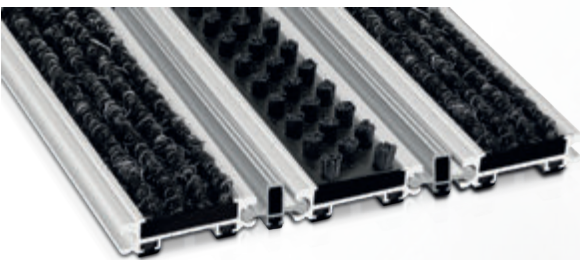

Carpet-Scraper-Brush

TABLE OF COMPONENTS

ELEPHANT	Insert modules							Frames & Connectors		
	Base Profile	Rubber	Brush	Carpet	Scraper	Connector	Modular scraper			
	HPE	L	F	H,H1,HZ	A	K C	S	HPS 2314 ELP	HPS 4312 ETP	BMB 2410
								HPS 3811	HPS 3510	

ELEPHANT FRAMES AND T PROFILES

Recessed ELEPHANT frame and T profile:

Aluminum frame is at maximum 3 mt length. Recessed type frames function to form the uneven edges at recessed type matting application. T Profile is used to make a clean connection in the large surfaced mats.

In order to adjust the height, EPDM gasket is removed from one foot of the base profile.

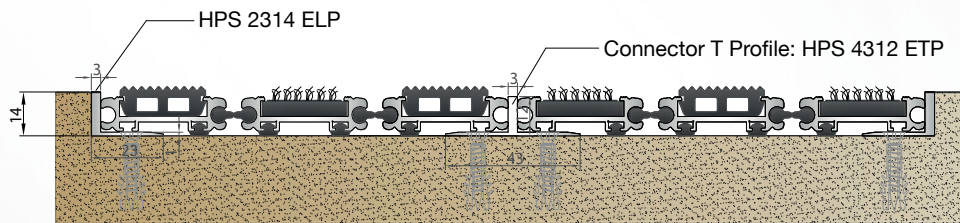

Pit Edge ELEPHANT frame :

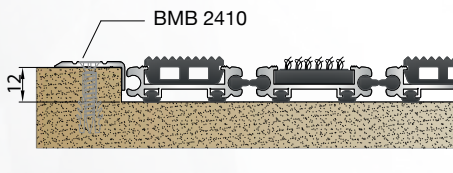

Aluminum frame is at maximum 3 mt length. Surface mounted pit edge frames are used at the recessed type mats in order to to hide the uneven edges.

Gasket Frame:

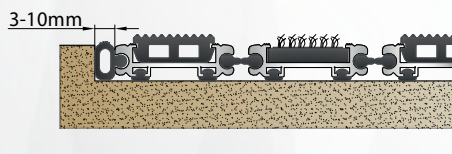

A small EPDM gasket can be used to cover the small gaps without using an aluminum frame.

Ramp Edge ELEPHANT frames:

Aluminum frame is at maximum 4 mt length. Two different types are available on request for a clean finish edge at the surface mounted Elephant mats.

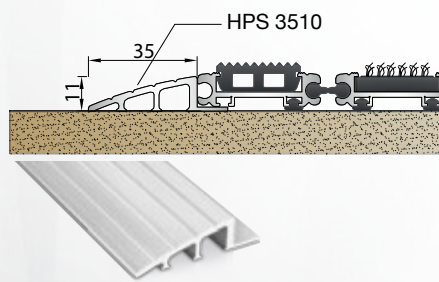
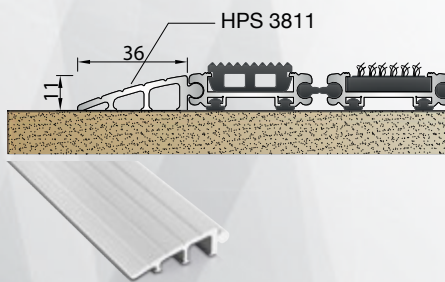



In Hippo Model matting system base profile is produced in aluminum in 19 mm height and 30 mm wide. By using inserts and modules, the height goes up to 23 mm and the gaps between the modules are 5/17/18 mm. Brush, carpet, rubber and modular scraper inserts are used for different zone purposes. In Hippo models rubber coated stainless steel wires are used as connector.

HPH F-K-F

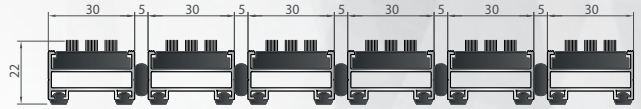

Brush-Connector-Brush

HPH F-A-F

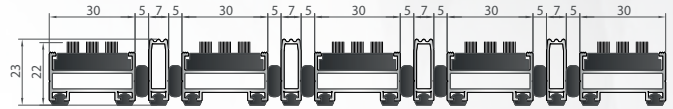

Brush-Scraper-Brush

HPH S-K-S

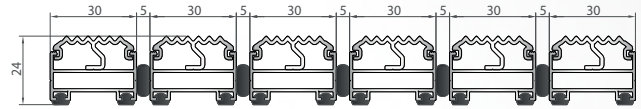

M.Scraper-Connector-M.Scraper

HPH S-K-F

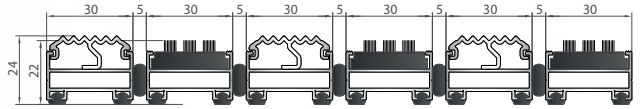

M.Scraper-Connector-Brush

HPH L-K-F

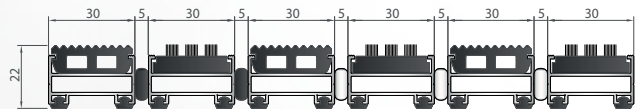

Rubber-Connector-Brush

HPH L-A-F

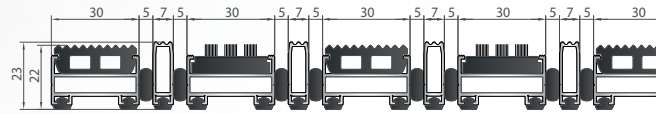

Rubber-Scraper-Brush

HPH L-K-L

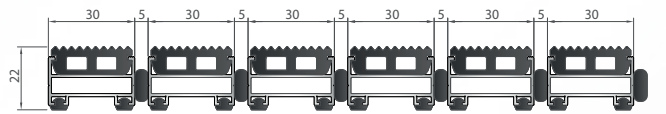
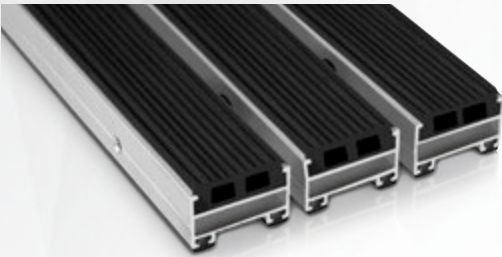

Rubber-Connector-Rubber

HPH L-A-L

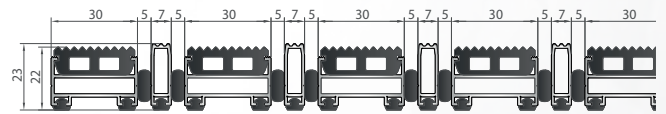
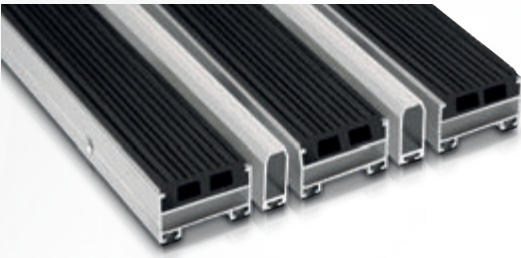

Rubber-Scraper-Rubber

HPH L-B-L

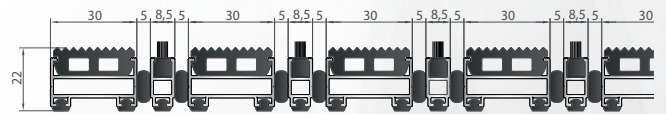

Rubber-Scraper-Rubber

HPH L-K-H

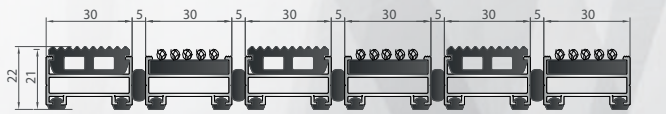

Rubber-Connector-Carpet

HPH L-A-H

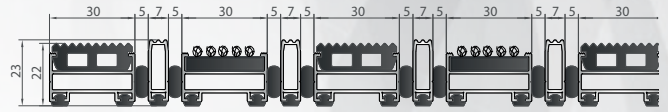

Rubber-Scraper-Carpet

HPH L-B-H

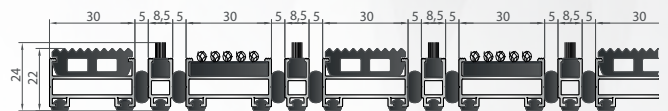
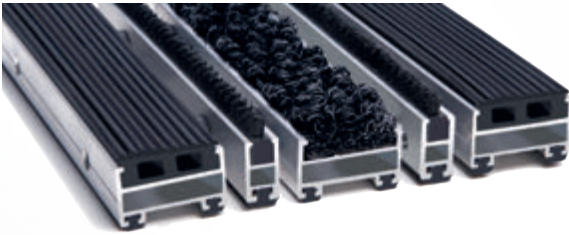

Rubber-Scraper-Carpet

HPH H-K-S

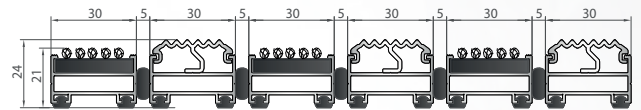

Carpet-Connector-M.Scraper

HPH H-K-H

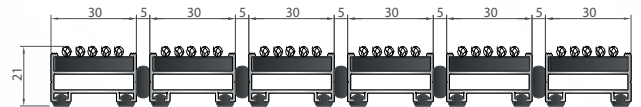

Carpet-Connector-Carpet

HPH H-K-F

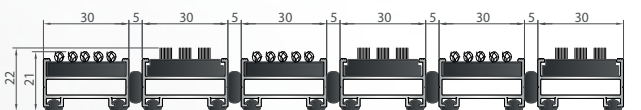

Carpet-Connector-Brush

HPH H-A-F

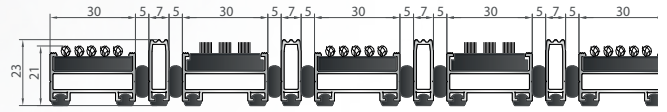

Carpet-Scraper-Brush

HPH H-A-H

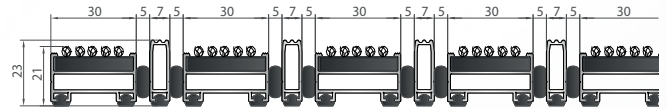

Carpet-Scraper-Carpet

HPH H-B-H

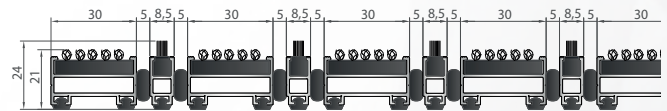

Carpet-Scraper-Carpet



HIPPO WIDE



Carpet-Connector-Carpet



Carpet-Scraper-Carpet

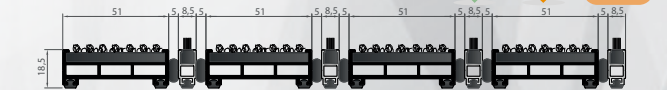

Carpet-Scraper-Carpet

The Hippo Wide model is designed to be more effective for absorption of fine dirt and moisture through their extra-wide ribs. It visually enhances indoor and covered entrance areas and achieves a high cleaning effect.

TABLE OF COMPONENTS

	Insert modules							Frames & Connectors		
	Base Profile	Rubber	Brush	Carpet	Scraper	Connector	Modular scraper			
HIPPO	HPH	L	F	H,H1,HZ	A B	K	S	HPS 2120 HLP BMB 2420	HPS 3919 HTP HPSH 3620	BMB 4222 HPSH 4620
HIPPO WIDE	HPW			H,H1,HZ	A B	K		HPS 2120 HLP BMB 2420	HPS 3919 HTP HPSH 3620	BMB 4222 HPSH 4620

HIPPO FRAMES AND T PROFILES

Recessed HIPPO frame and T profile:

Aluminum frame is at maximum 3 mt length. Recessed type frames function to form the uneven edges at recessed type matting application. T Profile is used to make a clean separation in the large surfaced mats. In order to adjust the height, EPDM gasket is removed from one foot of the base profile.

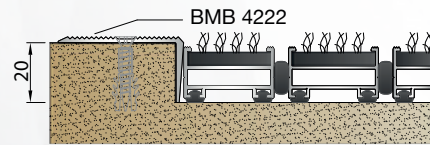
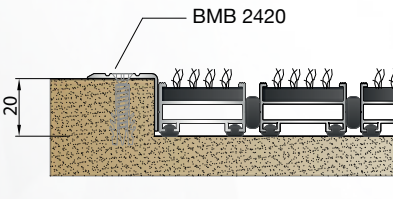
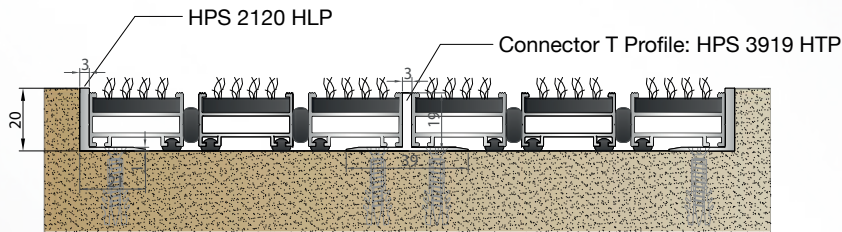

Pit Edge HIPPO frame :

Aluminum frame is at maximum 3 mt length. Surface mounted pit edge frames are used at the recessed type mats in order to hide the uneven edges and to cover the short gaps between the mat and the pond edge.

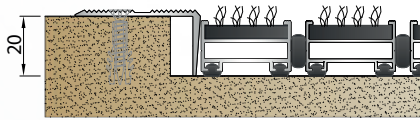

Ramp Edge HIPPO frames:

Aluminum frame is at maximum 4 mt length. Two different types are available on request for a clean finish edge at the surface mounted Hippo mats.

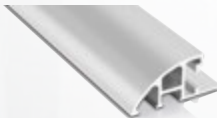
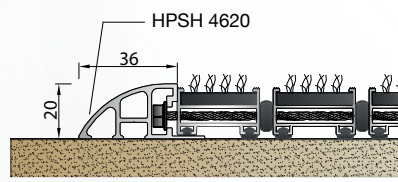
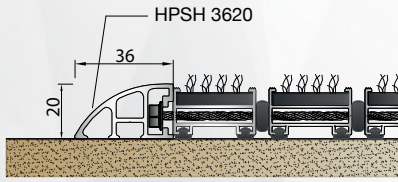



In Ant Model matting system, base profile is produced in aluminum in 38,5 mm height and 33 mm wide. 2,5 mm thickness of the Ant base profile allows the system to bear heavy loads. By using different inserts, the height goes up to 44 mm and the gap is always 5 mm. Brush, scraper, carpet, rubber and modular scraper inserts are used for different zone purposes. In Ant Model matting system, rubber coated stainless steel wires are used as connector.

HPA F-K-F

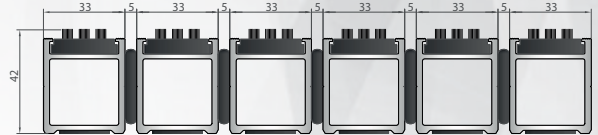

Brush-Connector-Brush

HPA S-K-F

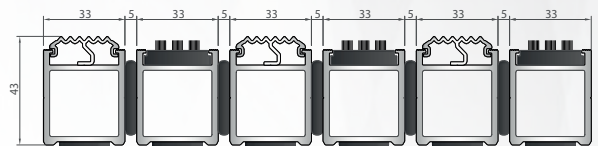

M.Scraper-Connector-Brush

HPA S-K-S

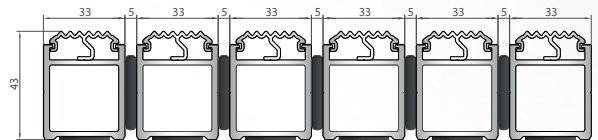

M.Scraper-Connector-M.Scraper

HPA L-K-F

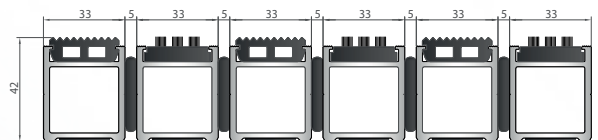

Rubber-Connector-Brush

HPA L-K-S

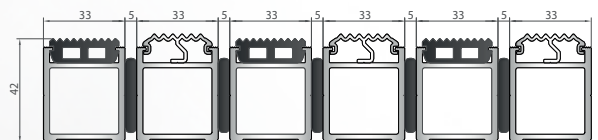

Rubber-Connector-M.Scraper

HPA L-K-L

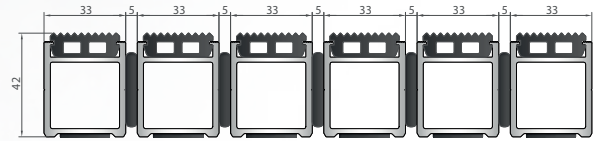

Rubber-Connector-Rubber

HPA L-A-L

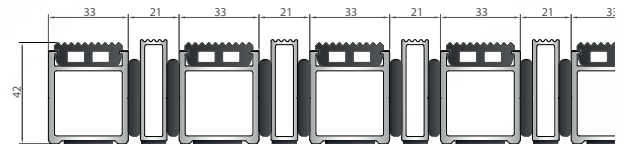
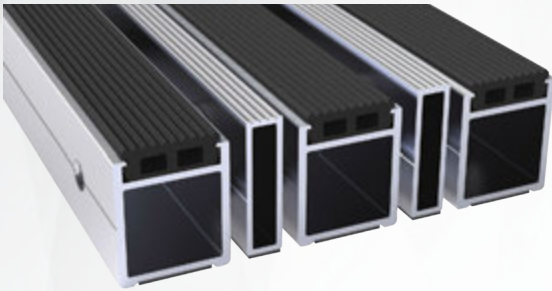

Rubber-Scraper-Rubber

HPA H-K-S

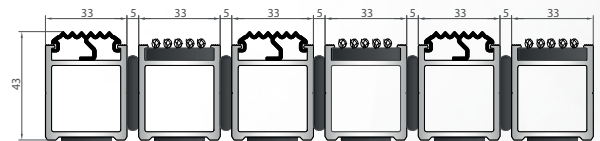
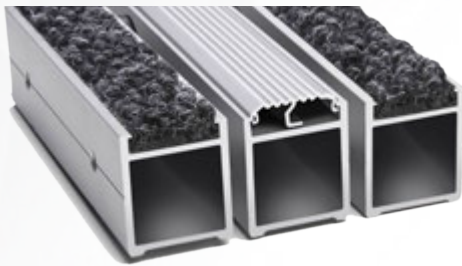

Carpet-Connector-M.Scraper

HPA L-K-H

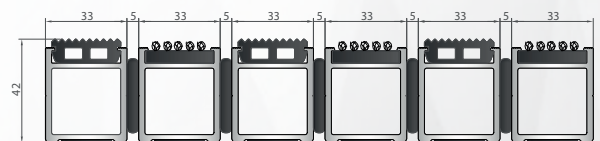

Rubber-Connector-Carpet

HPA H-K-H

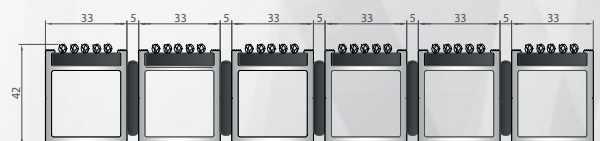

Carpet-Connector-Carpet



TABLE OF COMPONENTS

ANT	Base Profile	Insert modules					Connector	Modular scraper	Frames & Connectors			
		Rubber	Brush	Carpet	Scraper							
	HPA	L	F	H,H1,HZ	A	K	S	HPS 3542 ALP	HPS 4040 ATP	BMB 4222	BMB 2420	

ANT FRAMES AND T PROFILES

Aluminum frame is at maximum 3 mt length. Recessed type frames function to form the uneven edges at recessed type matting application. T Profile is used to make a clean separation at the large surfaced mats.

In Ant model recessed frame, firstly the recessed profiles are mounted on the floor, secondly the levelling is done with the 2 mm epoxy, and then the system is placed on the floor.

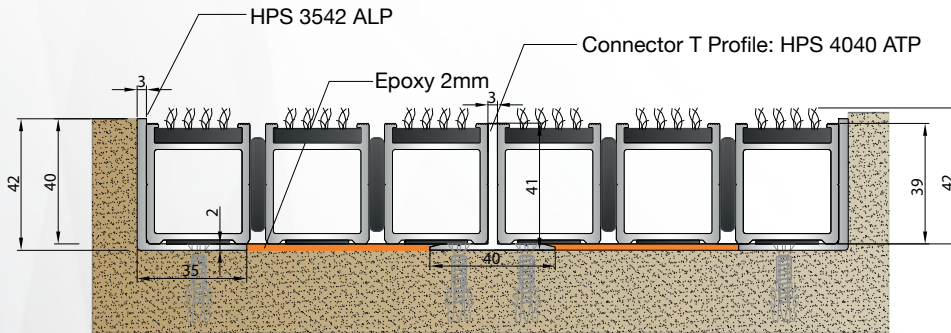

Pit Edge ANT frame :

Aluminum frame is at maximum 3 mt length. Surface mounted pit edge frames are used at the recessed type mats in order to cover the uneven edges and to fulfill the short gaps between the mat and the pond edge.

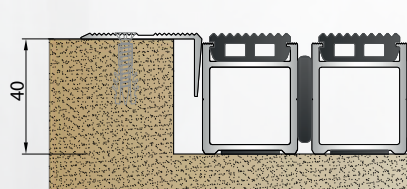
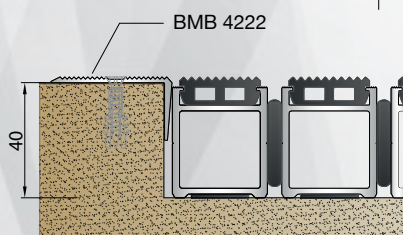
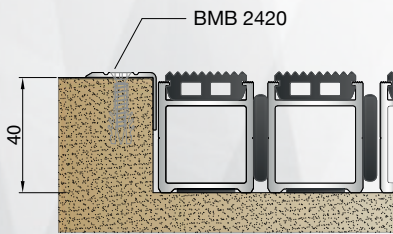

Dolphin matting system is the dirt control mat for the toughest requirements. It's a ready-made doormat with brushes and edge frame. The height of the base modul is 23 mm and the gap between the modules is 5 mm. Rubber coated stainless steel wires are used as connector. The mat is extremely easy to install in front of main entrances, steps, stairways etc. Special hard plastic ribs and nylon brushes effortlessly and reliably collect coarse dirt, even from shoes with a deep tread, thereby reducing the costs of cleaning indoor areas.



Rhino model is heavy-duty stainless steel matting system to keep the dirt, dust and moisture outside the building. Steel support base, inserts and rods are used to form the matting system and the height of the mat is 19.50 mm. Rhino model is produced in Type 304 stainless steel and is suitable for interior and exterior use.

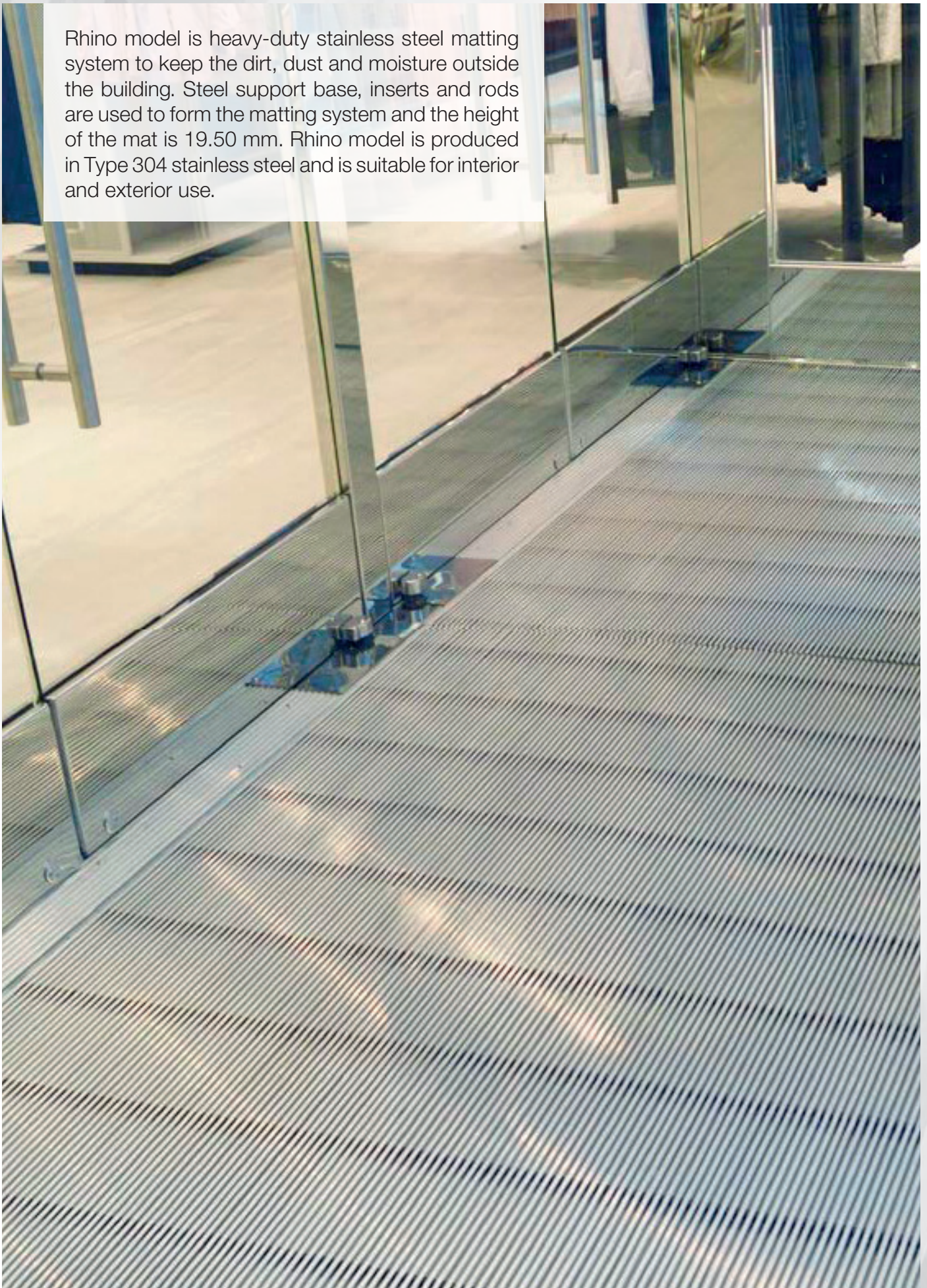



RHINO MAT

Stainless Steel Matting System

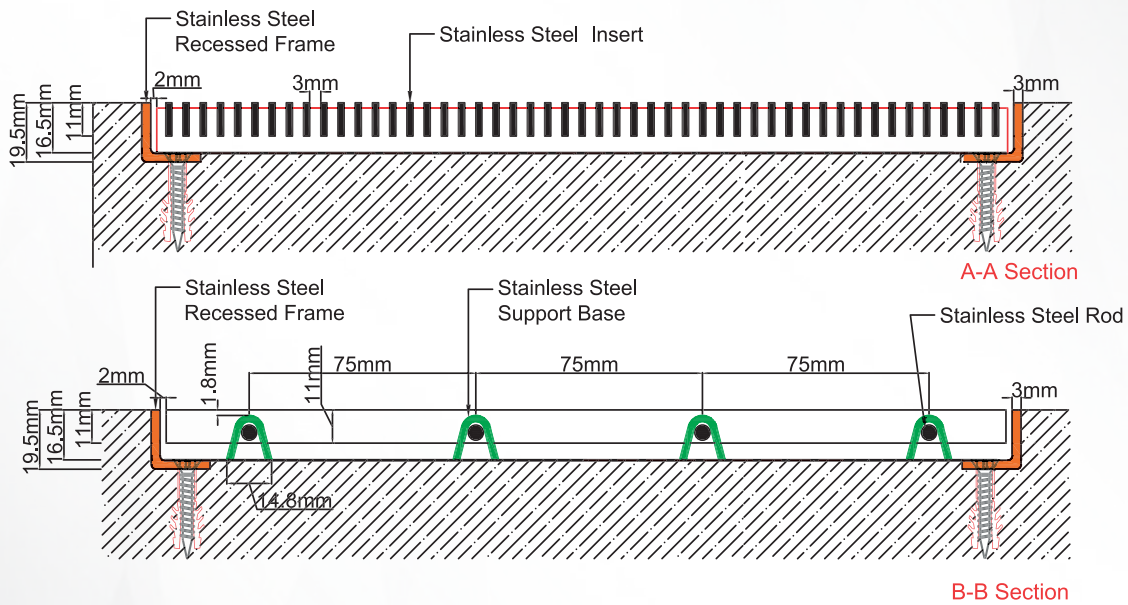
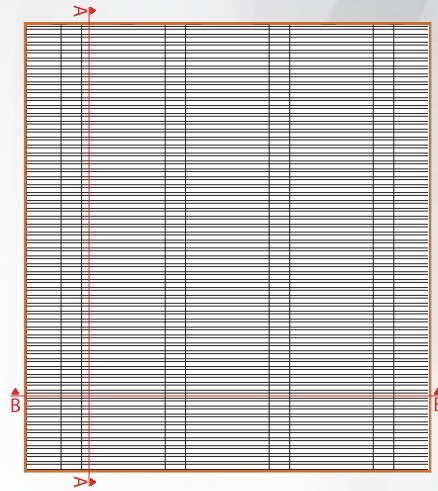
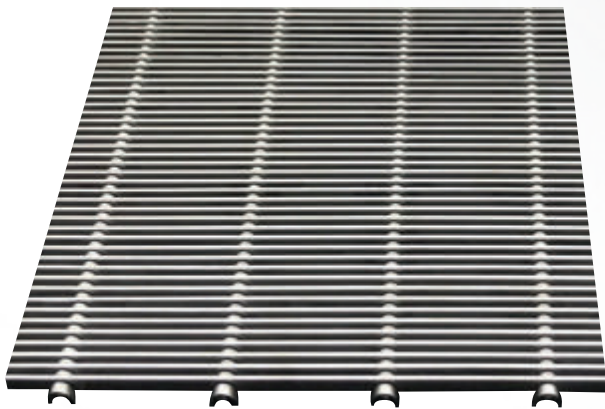

Rhino model is designed by stainless steel inserts placed to the stainless steel support base. Stainless steel rods are used between support base and inserts to form the matting system.

Rhino model stainless steel mat features :

- High-end, high tech appearance with clean architectural lines.
- Excellent for removing dirt & debris from shoes.
- Manufactured from Type-304 Stainless Steel
- With the rolling load capacity 250 kg per wheel
- All-weather durability and easy cleaning

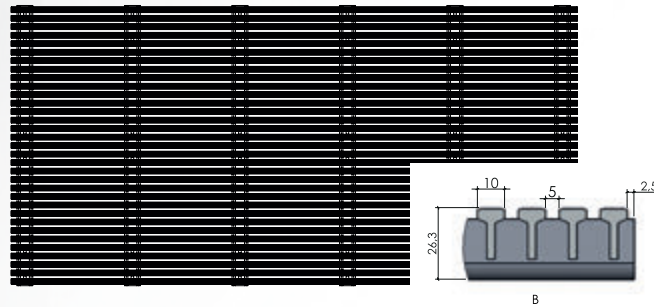
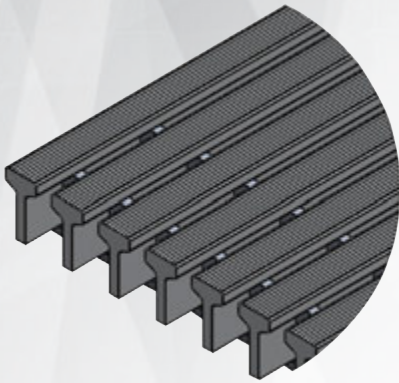

**TACO MAT****Aluminum Matting System**

Taco mats are well suited for both interior and exterior applications and are designed with a sculpted shape to increase slip resistance and provide a walking surface that will remove debris as it is carried into the building by foot traffic. The completed assembly provides openings between tread rails to allow dirt and debris to be captured and keep the interior of your building safe and clean.

All styles feature:

- Clean architectural lines for an elegant, high-tech appearance
- Safe, heel-proof design
- All-weather durability and easy cleaning
- Gratings can be temporarily removed for thorough cleaning
- Excellent choice for applications involving wheeled equipment



LOGO MAT

Logo mats are custom-made mats according to design. The selected logo is integrated via carpets that have color of the related logo part. For matting systems, logo is also engraved to the aluminum or stainless steel body and is integrated to the system.

For framed carpet models, integrated logo is framed with rubber or aluminum profile.



For matting systems, there is alternative to engrave logo via aluminum or stainless steel body by laser cutting. Metal Engraved Mats are durable and provides limitless selection of our mats with any combination.

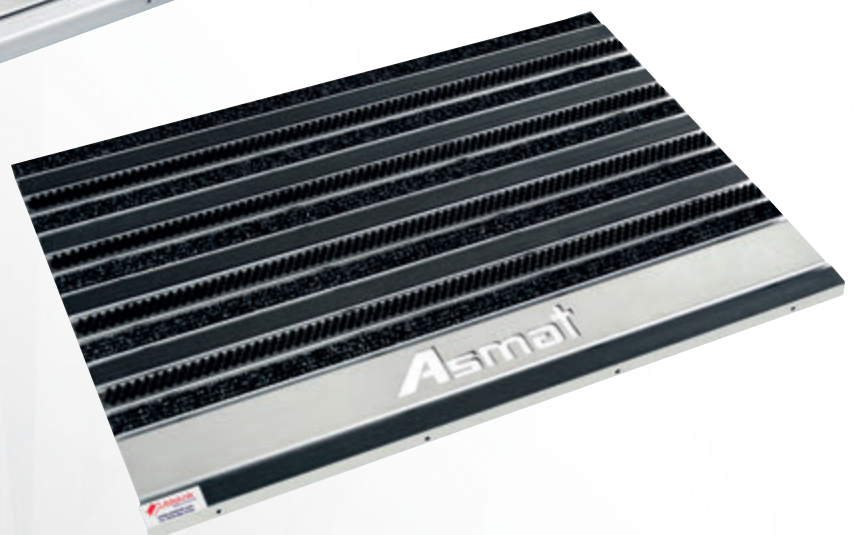
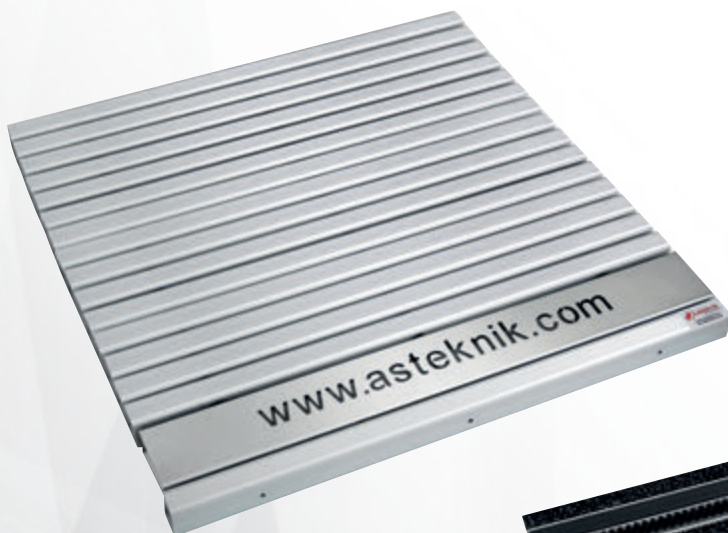

Regular maintenance and cleaning programme will help to extend the useful life of the matting systems. Cleaning frequency and the cleaning agents depends on the level of soiling.

Weak soiling:

Can be cleaned with a powerful vacuum cleaner. It is important to use a "wide-head" vacuum tool in order to maximize suction/cleaning power with the varying heights between the aluminum strips and the insert material. Inspect your recessed metal mat daily for chewing gum and remove before it becomes hardened and compacted. For small wet spills, use a clean cloth or absorbent material to soak up as much of the spill as possible.



Mid Soiling:

The pond needs to be cleaned as frequently as necessary to prevent a build-up of dirt and moisture under your roll-up mat/grid. After cleaning the surface of the mat with a powerful vacuum cleaner, the mat can be moved away for sweeping the bottom part with a broom and a mop. Be careful not to roll the mat too tight.



Heavy soiling:

If the mat is heavy soiled, the effective cleaning method is to use an on-site pressure washer. Clean mats, stand on to dry and replace in cleaned/disinfected recessed pond. Yet another method to periodically deep clean your mats is to take your mats or grids to a commercial car wash and use cleaning wand until mats are clean.



Important notes:

* Elephant matting system requires to be cleaned by vacuum mostly since it is a closed system. There is no need to remove the mat.

* While cleaning the Ant matting systems, do not roll the mat since the system is heavy. Instead, use metal hook on both opposite sides which can be provided by Asteknik to hold and move away the mat easier.

In order to determine the right map, first of all, it is necessary to determine the area where the mat is used inside or outside and in which zone. And then it is needed to be determined whether the mat is over the floor or recessed.

If the mat will be over the floor ; the required size of the mat is determined according to the number of modules and dimensions and appropriate ramp edge frame is selected.

If the mat will be recessed, there are 2 cases; the pond is not opened yet or the pond is already opened.

For the case, the pond is not opened yet, the dimensions of the pond should be determined according to the desired mat's finished dimensions. Finished dimensions should be identified by calculating the number of modules and dimensions (or simply by looking at the 'Asmat Walking Way Dimensions Table'). The size of the pond should always be 2-3 mm bigger than the size of the mat at all edges, to ensure the expansion tolerance. Recessed L profiles are recommended to be used for a clean finish. The depths of the ponds are recommended to be as follows :

- For Elephant : 14 mm
- For Hippo : 20 mm
- For Ant : 40 mm
- For Dolphin : 18 mm

For the case, the pond is already opened, the size of the suitable mat should always be determined 2-3 mm smaller than the pond to ensure the expansion tolerance. If there's a bigger gap than 2-3 mm between the mat and the pond, then the space can be filled by pit edge profiles.

Whenever possible, mats will be produced in one piece. For mats larger than 2,5 mt and heavier than 50 kg, the mat will be divided. In the division lines, T profiles are recommended to be used for clean finish and durability. The division line should not be in the center of the walking direction.

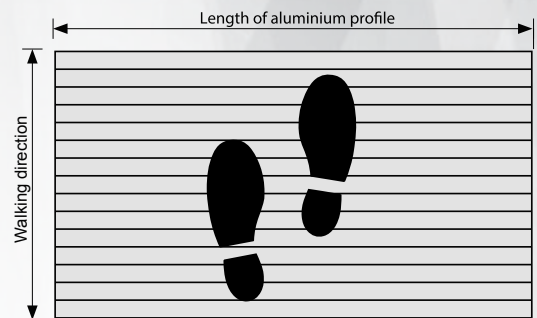
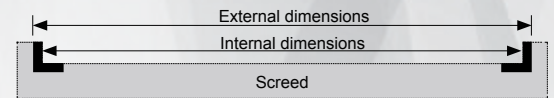

ELEPHANT

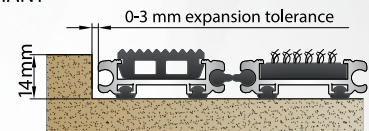

HIPPO

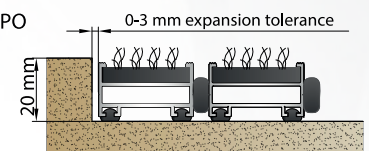

ANT

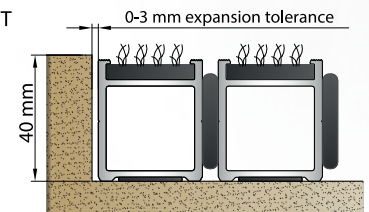

DOLPHIN

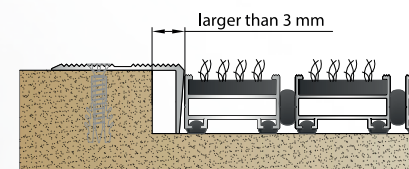
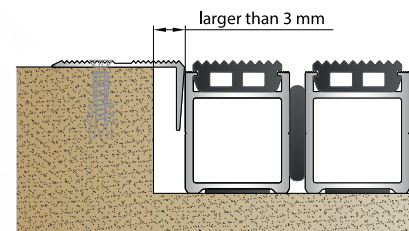
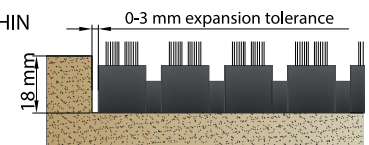



OKMEYDANI HOSPITAL
(Turkey)



SKYLAND İSTANBUL
(Turkey)



**NİDAPARK
KÜÇÜKYALI**
(Turkey)



**NİDAPARK
BAŞAKŞEHİR**
(Turkey)



G TOWER
(Turkey)



GÖZTEPE HOSPITAL
(Turkey)



**İZMİR EKONOMİ
UNIVERSITY**
(Turkey)



LİLA COSMETICS
(Turkey)



EKOL LOGISTICS
(Turkey)



CER İSTANBUL
(Turkey)



HALKBANK Branches
(Turkey)



OZYEGIN UNIVERSITY
(Turkey)



MALTEPE CEVAHIR HOTEL
(Turkey)



McDONALD'S Branches
(Turkey)



PETROL OFISI Stations
(Turkey)



RAMADA HOTEL
(Turkey)



PALLADIUM MALL
(Turkey)



HALIC CONGRESS CENTER
(Turkey)



EMAAR SQUARE
(Turkey)



MEMORIAL HOSPITAL
(Turkey)



TERRACE GARDEN
(Turkey)



TOSYALI HOLDING
(Turkey)



SURYAPI EKSEN
(Turkey)



**ZIRAAT BANKASI
Branches**
(Turkey)



28 MALL
(Azerbaijan)



AMERICAN SCHOOL OF C.SCIENCE
(United Arab Emirates)



BAKU CONVENTION CENTER
(Azerbaijan)

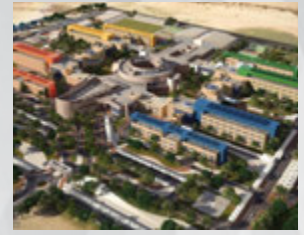

BAYNUNAH ACADEMIC COMPLEX
(United Arab Emirates)



DANAT AL EMARAT HOSPITAL
(United Arab Emirates)



DEIRA FISH MARKET
(United Arab Emirates)



GASCO HABSHAN PROJECT
(United Arab Emirates)



HARAMAIN HIGH SPEED RAILWAY MADINAH STATION
(Saudi Arabia)



HARAMAIN HIGH SPEED RAILWAY MAKKAH STATION
(Saudi Arabia)



INTERNATIONAL SCHOOL OF C.SCIENCE
(United Arab Emirates)



THE GREEN PLANET
(United Arab Emirates)



UNIVERSITY OF DAMMAM HOSPITAL
(Saudi Arabia)



SOFIA AIRPORT
(Bulgaria)



BURGAS AIRPORT
(Bulgaria)



MALL OF ARABIA
(Saudi Arabia)



QATAR NATIONAL BANK
(Qatar)



ASAS TOWER
(United Arab Emirates)



KING FAHD AIR BASE
(Saudi Arabia)



PALACE OF JUSTICE
(Kosovo)



BAKU BUS STATION PROJECT
(Azerbaijan)



DREAMLAND PROJECT
(Azerbaijan)



NEW DOHA INTERNATIONAL AIRPORT
(Qatar)



QATAR ACADEMY
(Qatar)



UMM AL HOUL POWER PLANT
(Qatar)



Merkez

Esenkent Mah. Buyruk Sk. No : 15/A
34776 Ümraniye - İstanbul

Tel : 0 216 466 72 63 (Pbx)

Faks : 0 216 466 72 64

e-posta : info@asteknik.com

web : www.asteknik.com

